

## LED Spotlight 7 W



**GlacialTech** has unique products in **SP07** series **LED spotlights**. It uses high power LED including **7 W** LED light source series products. It has excellent features like long lifetime (min. 20,000 hrs), high luminous efficacy and reduces environmental pollution. The SP07 spotlights can suitable for use 100-240V AC. It can be used for spotlight and outdoor lighting.

**GlacialTech** 的 **SP07** 系列使用高亮度 **LED**，其中包含 7 W 之系列產品可代替傳統投射燈，並具備比傳統燈泡更優良的特性如：使用壽命長(高於 20,000 小時)、高發光效能並具備環保節能特性，適用於 100-240V AC 電壓，主要使用於投射燈與戶外照明。

### ➤ Features 特性

- Indoor and outdoor use 室內/戶外照明
- Comparable with mercury lamps 75 W 可等同於傳統 75 W 水銀燈泡光效
- Power factor > 0.9 for 115V AC; Power factor > 0.8 for 230V AC  
功率因素 > 0.9 (115V AC) ; 功率因素 > 0.8 (230V AC)
- High power driver efficiency > 80% 電源轉換效率 > 80%
- High luminous efficacy LED 高發光效能 LED
- Non-UV or IR radiation 無紫外線與紅外線傷害
- Compliance with safety standard regulations : EN60598, EN61347-1+EN61347-2-13, EN55015+EN61547, EN60825-1, FCC Part 18  
遵循歐盟安規及北美 FCC 標準： EN60598、EN61347-1+EN61347-2-13、EN55015+EN61547、EN60825-1、FCC Part 18
- Cool light prevents heat buildup and associated heat degeneration 低溫光可減少環境溫度的上昇
- Energy saving and environment friendly 具環保節能效益
- IP64 dust proof IP64 防水防塵等級



## ➤ Specifications 產品規格

Model No. 型號	GL-SP-7WW	GL-SP-7CW
CCT (Typical) 色溫	3000 K	6000 K
Typical Power Consumption 消耗瓦數	10 W	10 W
Luminous Flux (lm) 光通量 (流明)	300 lm	450 lm
Input Voltage 輸入電壓	100-240V AC	
Operation Temperature 操作溫度	-20°C — +40°C	
Typical Luminous Efficacy 發光效能(流明/瓦)	30 lm/W	45 lm/W
CRI 演色性	> 80	> 75
Beam Angle 光束角	30°/60°	
Warranty 保固期	2 Years	
Applications 應用	Outdoor Lighting/ Architectural Lighting/ Landscape Lighting/ Spot Lighting/Public Place Lighting 戶外建築照明與裝潢/園藝造景/投射燈/公共空間	
Outline Dim. 外觀尺寸(公厘)	Ψ 140*140*85 (mm)	
Net. Weight 淨重(公斤)	0.68 (Kgs)	
Package 包裝方式	12 Boxes / Carton	
Box Dimension/ Weight 盒裝尺寸(公厘)/重量(公斤)	L=160*155*102(mm)/0.70 (Kgs)	

➤ **Candle Power Distribution Curve 配光曲線圖**

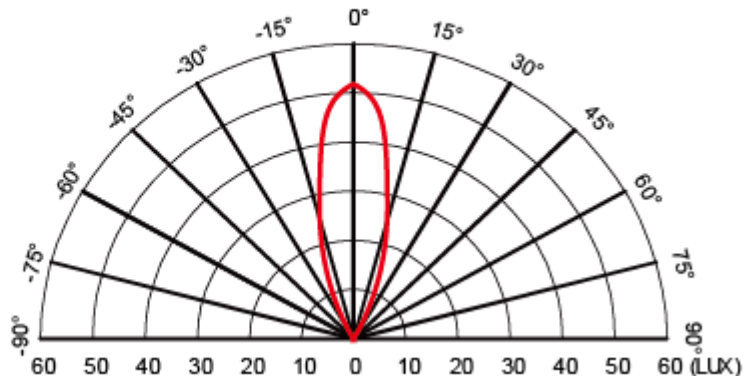
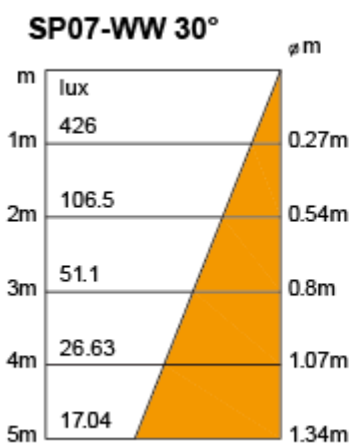
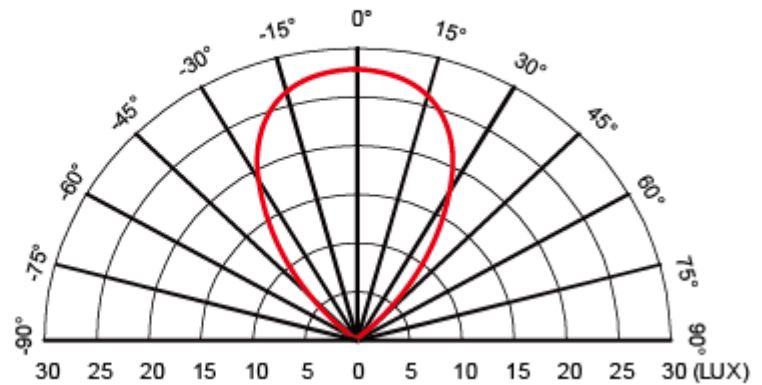
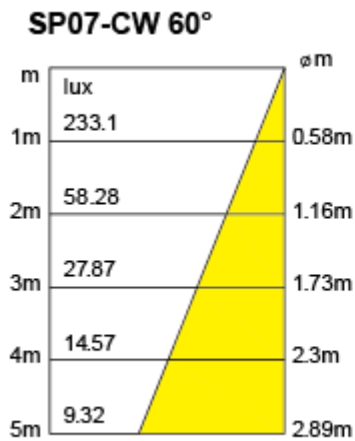
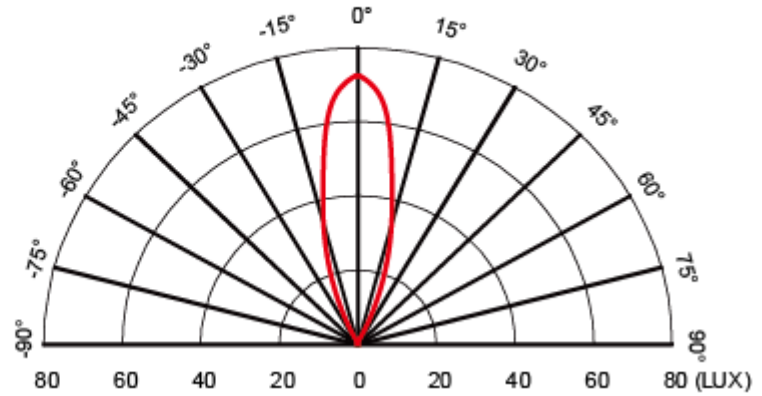
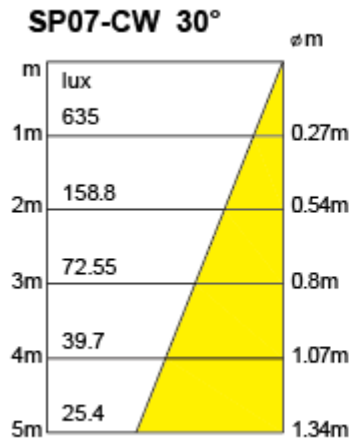

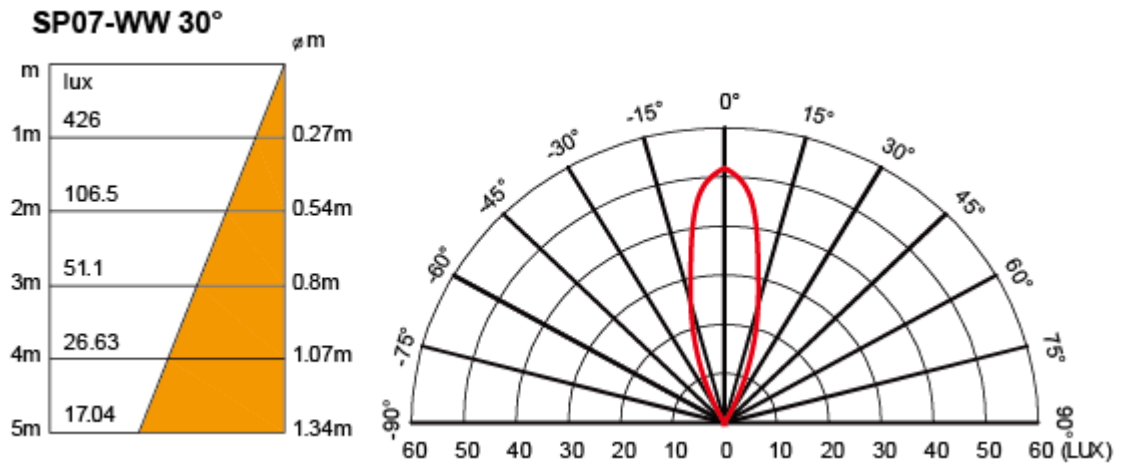

➤ **Dimensions 尺寸**

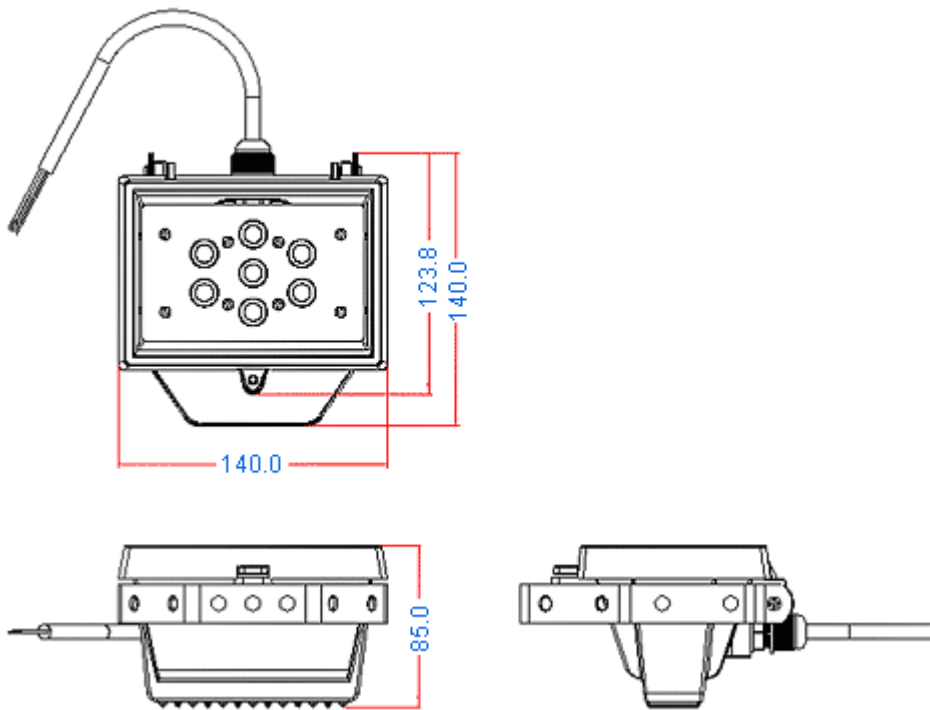

➤ **Energy Saving & CO<sub>2</sub> Reduction Comparison**

**Table 節能減碳比較表**

Item 項目	GL-SP-7CW (6000 K)	Mercury Lamps
Life Time 壽命(小時)	20,000 hrs	3,000 hrs
Typical Power Consumption 消耗瓦數(=A)	10 W	75 W
Typical Power Consumption per year 每年消耗瓦數(12hrx365day/KWh)*A=B	43.8 KW	330 KW
CO <sub>2</sub> Quantity (Kgs/year) 每年CO <sub>2</sub> 排放量 (公斤) (0.637*B=D)	28 Kgs	210 Kgs
Energy Saving Rate 與鹵素燈泡相比之省電率 (Compare with Spotlight Bulbs)	87%	



CO<sub>2</sub> calculation reference IPCC guide=0.637 CO<sub>2</sub>/KWh (Taiwan)